

CE 107402570 D

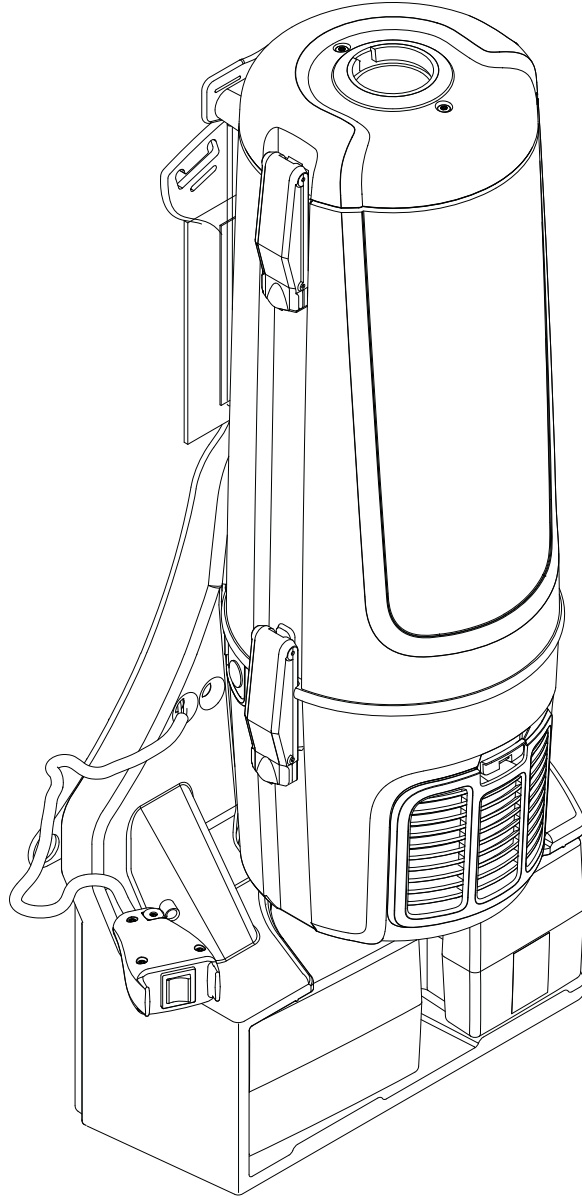

INSTRUCTIONS FOR USE
ORIGINAL INSTRUCTION

BRUGSANVISNING

BETRIEBSANLEITUNG

MODE D'EMPLOI

INSTRUCCIONES DE USO

GD 5 BATTERY

”

شريف صنعت پارسا



Nilfisk

trusted since 1906

EN	English.....	08
DE	Deutsch	13
FR	Français.....	18
NL	Nederlands	23
IT	Italiano	28
NO	Norsk	33
SV	Svenska.....	38
DA	Dansk.....	43
FI	Suomi.....	48
ES	Español.....	53
PT	Português.....	58
EL	Ελληνικά	63
TR	Türkçe.....	68
CS	Čeština.....	73
PL	Polski	78
HU	Magyar	83
RO	Română	88
BG	Български	93
RU	Русский.....	98
ET	Eesti.....	103
LV	Latviski	108
LT	Lietuviškai	113

Hose connection

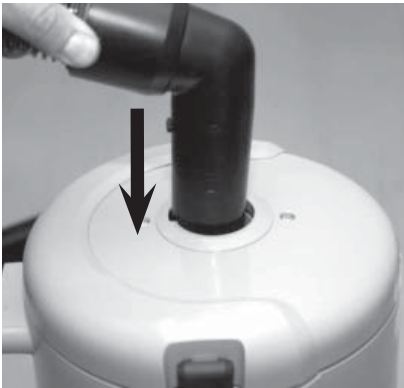

Adjustment of strap position on support plate



Adjustment of tension ties on the strap's support plate



Adjusting the vacuum cleaner to sit comfortably

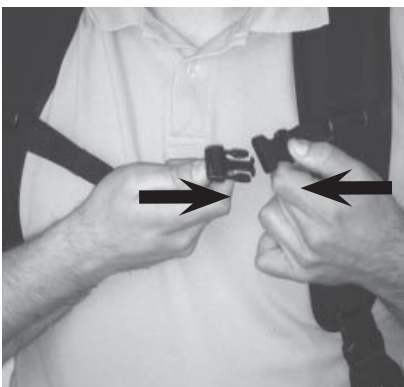
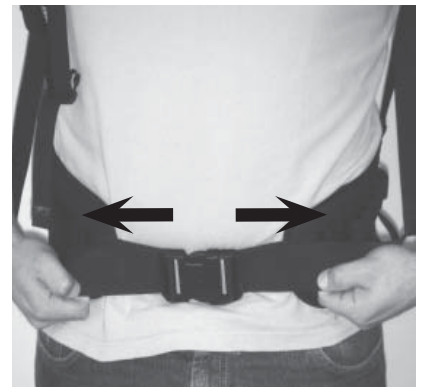

Cord set

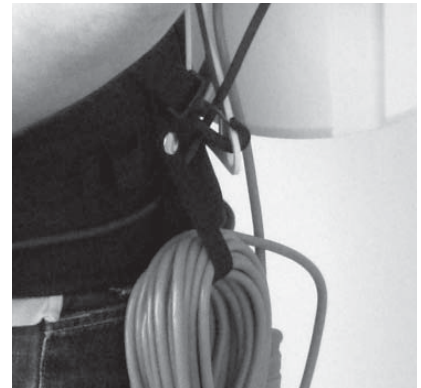

Cable relieve

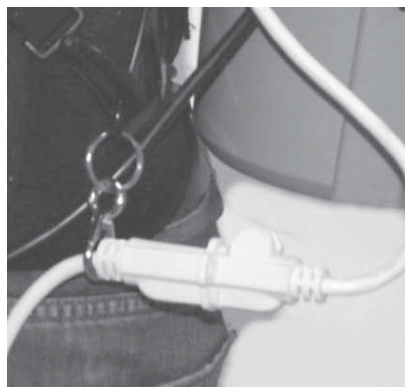

On/Off

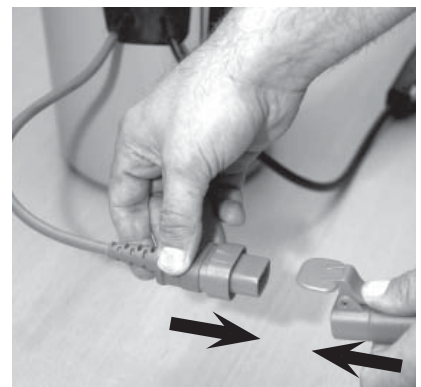

Dust bag

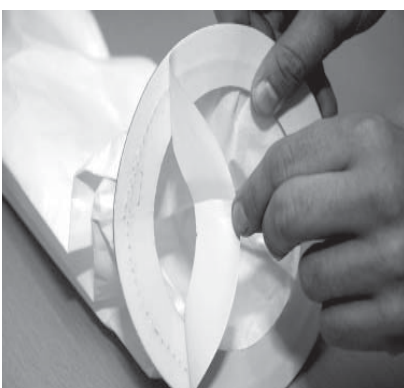

Bag filter

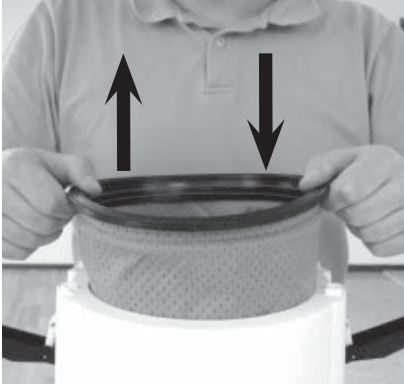

HEPA filter

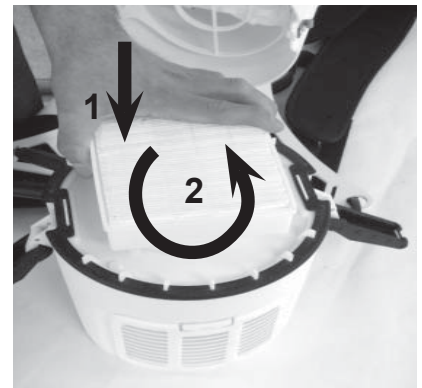
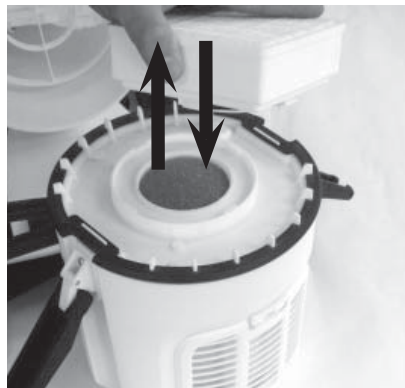
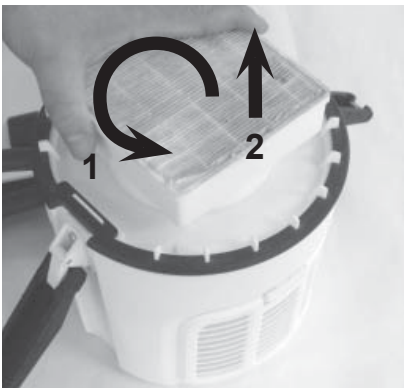
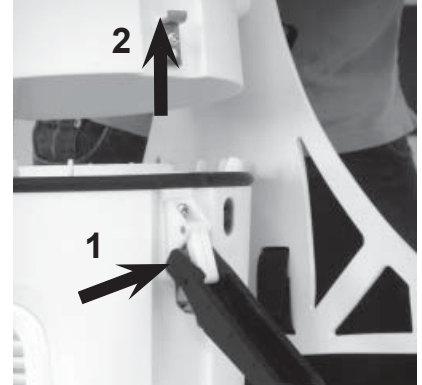

Pre filter to be replaced by use of every 5-10 dust bags

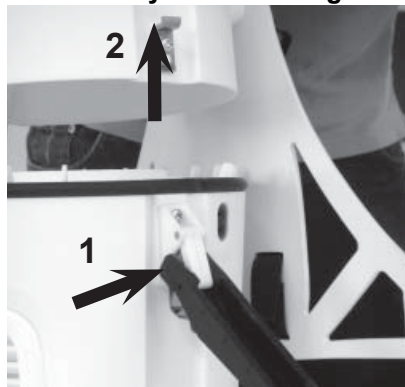
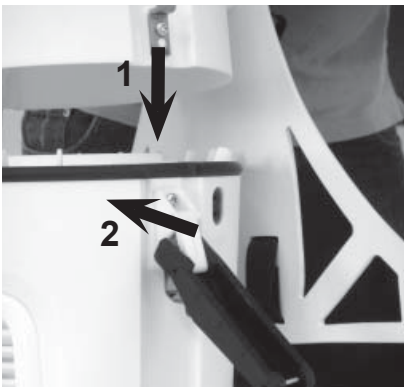

Exhaust filter to be replaced once/twice per year



Electro nozzle

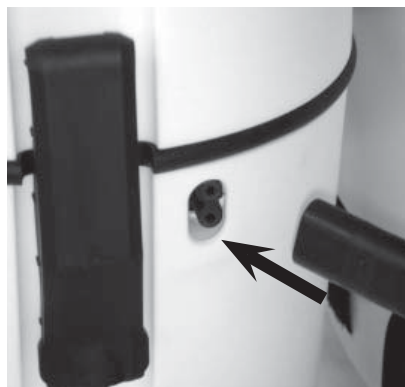

Connection of bent end and handle grip

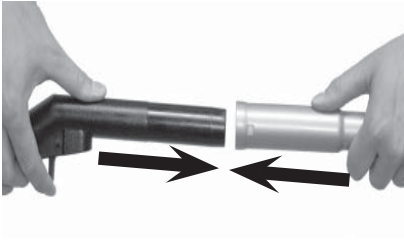

Extension tube

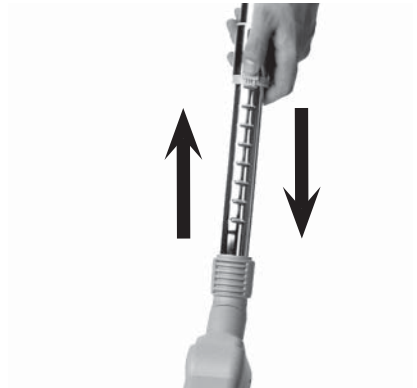

Round brush nozzle



Combi nozzle



Crevice nozzle



Charger operations

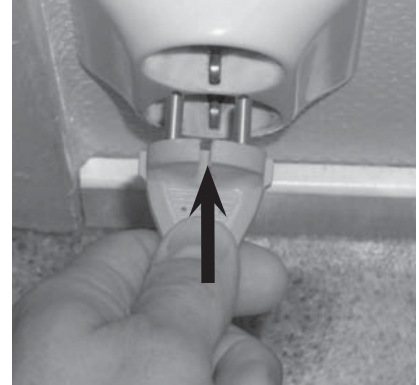
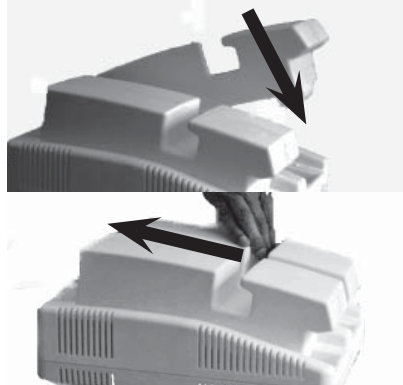

Remove battery

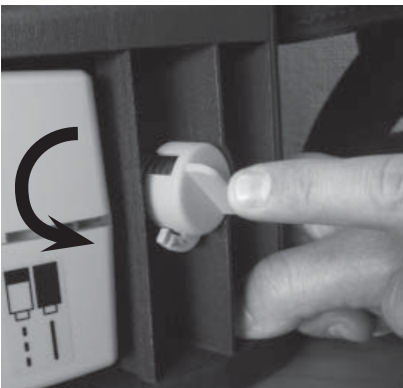

Install battery

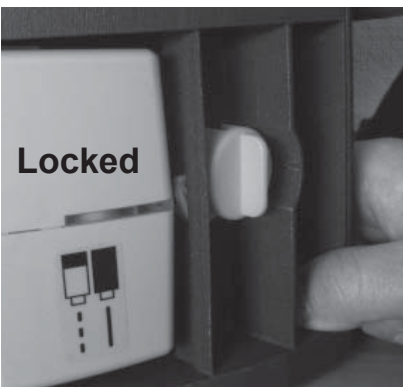
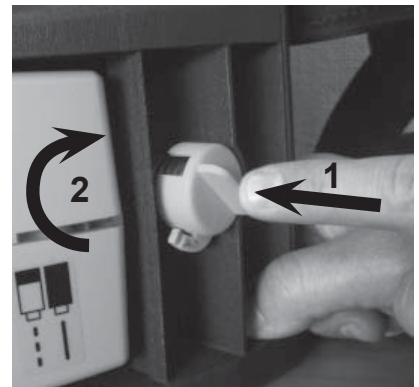

English

Instructions for use



Prior to using the appliance for the first time, be sure to read this document through and keep it ready to hand.

Before using the vacuum cleaner make sure that the voltage shown on the rating plate on the vacuum cleaner corresponds with the main voltage.

This machine is intended for commercial use, for example in hotels, schools, hospitals, factories, shops, offices and rental businesses.

Purpose and intended use

The appliance is suitable for picking up dry, non-flammable dust.

Symbols used to mark instructions

WARNING



Danger that can lead to serious injuries or even death.

CAUTION



Danger that can lead to minor injuries and damage.

Important warnings

WARNING



- The vacuum cleaner must not be used for the suction of water, liquids or inflammable gases.
- No changes to the mechanical, electrical or thermal safety devices must be made.
- This appliance can be used by children aged from 8 years and above and persons with reduced physical, sensory or mental capabilities or lack of experience and knowledge if they have been given supervision or instruction concerning use of the appliance in a safe way and understand the hazards involved.
- Children shall be supervised to make sure that they do not play with the appliance.
- Cleaning and user maintenance shall not be made by children without supervision.
- Operators shall be adequately instructed on the use of this machine.
- This machine is for dry use only.

CAUTION



- This machine is for indoor use only.
- This machine shall be stored indoors only.

This machine is equipped with a thermal cut-out to protect the motor and other vital machine parts from overheating. Should the machine cut out, you will have to wait at least 5-10 minutes for it to automatically reset. While you are waiting, switch the machine off and unplug it, then check the hose, dust bag and filters to be sure that nothing is blocking the flow of air through the machine.

The filter/filters on selected models in this product range are manufactured using HEPA material. This is not a HEPA certified machine and should not be used in cleaning environments where approved HEPA machines are required.

The vacuum cleaner is supplied with a paper dust bag already in place. t a properly fitted dust bag.

Electrical connection

WARNING



- The vacuum cleaner must not be used if the electrical cable or plug show any sign of damage. Regularly inspect the cable and the plug for damage. If this becomes damaged, it should be repaired only by Nilfisk or an authorised Nilfisk Service Dealer, in order to avoid a hazard.
- Do not handle the electrical cable or plug with wet hands.
- Do not unplug by pulling on cable. To unplug, grasp the plug, not the cable. The plug must always be removed from the socket outlet before starting any service or repair work of the machine or the cable.

Hazardous materials

WARNING



Vacuuming up hazardous materials can lead to serious or even fatal injuries.

The following materials must not be picked up by the vacuum cleaner:

- hazardous dust
- hot materials (burning cigarettes, hot ash, etc.)
- flammable, explosive, aggressive liquids (e.g. petrol, solvents, acids, alkalis, etc.)
- flammable, explosive dust (e.g. magnesium or aluminum dust, etc.)

Maintenance

Always keep the cleaner in a dry place. The cleaner is designed for continuous heavy work. Depending on the number of running hours – the dust filters should be renewed. Keep the container clean with a dry cloth, and a small amount of spray polish.

For details of after sales service contact Nilfisk directly.

Warranty

Our general conditions of business are applicable with regard to the guarantee.

Unauthorised modifications to the appliance, the use of incorrect brushes in addition to using the appliance in a way other than for the intended purpose exempt the manufacturer from any liability for the resulting damage.



As specified in European Directive 2002/96/EC on old electrical and electronic appliances, used electrical goods must be collected separately and recycled ecologically.

Contact your local authorities or your nearest dealer for further information.

Instruction for use - batteries

This cleaner is operated by a Lithium-ion battery. One battery is delivered as standard equipment with the machine. There is an LED-indicator in the upper end of the battery. When the battery is charged and running at normal power level the LED-indicator is lit with fixed green light.

When the indicator at the battery starts to flash - less than 30 percent of the battery power remains. There is also a possibility to order an extra battery - by doing this the operating time will be extended to approximately 60 min.

There is a push button at the battery. The purpose of this button is to show the remaining power of the battery if the battery is stored outside the cleaner. Push the button down and the capacity of the battery will be shown at the LED-indicator for 30 seconds. When the indicator at the battery starts to flash - less than 30 percent of the battery power remains, and it will soon need to be charged. Note! In order to save power, these batteries will be set in a storage mode if not been used within a period of 4-8 weeks. If this occurs please push the reset button at the battery.

Instruction for use - charger

The charger should be placed at a table, shelf or be mounted on a wall. If it is mounted on a wall - choose screws and if necessary, wall plugs to suit the charger to the material of the wall.

When the LED-indicator at the batteries starts to flash, there is less than 30 percent of the battery power remaining. The battery will run normally until 0% then it switches itself off. Do the following to charge the batteries:

1. Connect the main cord of the charger to the charger.
2. Attach the battery to the charger.
3. Pull the battery backwards to the outlet of the charger.
4. Plug in the other end of the main cord to an electrical wall outlet.

The batteries will be charged automatically. The LED indicator at the battery flashes green to indicate that the battery is being charged. When the battery is fully charged, the LED indicator at the battery will be lit with fixed green light.

Two batteries will be fully charged within 90 minutes. The charged battery can remain on the charger until it is to be used. There is no risk of over-charging.

WARNING



- Before every use - check the batteries for any sign of damage.
- Do not immerse in any liquid.
- Do not charge below 0° Celsius.
- Do not store batteries along with metal objects due to risk of short circuit.
- This cleaner uses Lithium-ion batteries.
- Never use non rechargeable batteries in this vacuum cleaner.
- Use only original batteries, when replacement batteries are required.
- If the batteries are leaking, return batteries to a disposal plant or a similar local facility.
- The batteries must be removed from the appliance before the appliance is scrapped.
- Protect the charger against moisture and store it in a dry place.
- Do not use the charger if it is wet.
- The mains voltage available must correspond to the voltage stated on the rating plate of the charger.
- Do not operate charger in explosive environment.
- Do not carry the charger by holding the main cord.
- Do not cover the charger.

Note! The battery performance will increase after the initial charge/discharge cycles.

Specifications

		GD 5 Battery
Battery type		Lithium-Ion
Nominal voltage battery	V	24
Energy/battery	Ah	6.9
Battery part number		147 1197 000
Run time 1 battery	minutes	30
Charge time	minutes	45
Operating temperature battery	°C °F	+0 to +40 32 to 104
Storage temperature battery	°C °F	-15 to +50 5 to 122
Airflow with hose and tube	l/second	25
Vacuum, at nozzle	kPa	20
Sound pressure IEC 704	dB(A)	76
Dust bag capacity	L.	4.2
Weight, cleaner and battery	Kg	7.7

Specifications and details are subject to change without prior notice.

CE		CE declaration of conformity	
Product:	Vacuum cleaner		
Type:	GD 5 Battery		
The design of the unit corresponds to the following pertinent regulations:	EC - Machinery Directive	2006/42/EC	
	EC - Directive EMC	2004/108/EC	
	RoHS Directive	2011/65/EC	
Applied harmonised standards:	EN 60335-2-69:2009 EN 62233:2008 EN 55014-1:2006 EN 61000-3-2:2006 EN 61000-3-3:2008 EN 55014-2:1997+A1:2001 EN 60335-1:2002+A11+A1+A12+A2+A13+A14: 2010		
Applied international standards and technical specifications:	IEC 60335-1:2001+A1+A2 IEC 60335-2-69:2002+A1+A2		
Name and address of the person authorised to compile the technical file:	Anton Sørensen General Manager, Technical Operations EAPC Nilfisk-Advance A/S Sognevej 25 DK-2605 Brøndby		
Identity and signature of the person empowered to draw up the declaration on behalf of the manufacturer:	 Anton Sørensen General Manager, Technical Operations EAPC Nilfisk-Advance A/S Sognevej 25 DK-2605 Brøndby		
Place and date of the declaration:	Hadsund, March 19, 2013		

HEAD QUARTER

DENMARK

Nilfisk-Advance A/S
Sognevej 25
DK-2605 Brøndby
Tel.: (+45) 4323 8100
www.nilfisk-advance.com

SALES COMPANIES

ARGENTINA

Nilfisk – Advance S.R.L.
Herrera 1855 6º piso Of. A-604
CP 1293 – Ciudad Autónoma de Buenos Aires
www.nilfisk.com.ar

AUSTRALIA

Nilfisk-Advance
Unit 1, 13 Bessemer Street Blacktown
NSW 2148 Australia
www.nilfisk.com.au

AUSTRIA

Nilfisk-Advance
Metzgerstrasse 68
A-5101 Bergheim/Salzburg
www.nilfisk.at

BELGIUM

Nilfisk-Advance NV/SA.
Riverside Business Park
Boulevard Internationale 55
Bruxelles 1070
www.nilfisk.be

CHILE

Nilfisk-Advance S.A.
San Alfonso 1462, Santiago
www.nilfisk.com

CHINA

Nilfisk-Advance Cleaning Equipment (Shanghai) Ltd.
No. 4189 Yindu Road
Xinzhuang Industrial Park
Shanghai 201108
www.nilfisk.cn

CZECH REPUBLIC

Nilfisk-Advance s.r.o.
VGP Park Horni Pocernice
Budova H2, Do Certous 1
Praha 190 00
www.nilfisk.cz

DENMARK

Nilfisk Danmark
Sognevej 25
DK-2605 Brøndby
www.nilfisk-advance.com

FINLAND

Nilfisk-Advance Oy Ab
Koskelontie 23E
02920 Espoo
www.nilfisk.fi

FRANCE

Nilfisk-Advance
26 Avenue de la Baltique
Villebon sur Yvette
BP 246
91944 Courtaboeuf Cedex
www.nilfisk.fr

GERMANY

Nilfisk
Geschäftsbereich der Nilfisk-Advance AG
Siemensstrasse 25-27
25462 Rellingen
www.nilfisk.de

GREECE

Nilfisk-Advance A.E.
8, Thoukididou Str.
Argiroupoli, Athens, GR-164 52
www.nilfisk.gr

HOLLAND

Nilfisk-Advance BV
Versterkerstraat 5
1322 AN Almere
www.nilfisk.nl

HONG KONG

Nilfisk-Advance Ltd.
Room 2001 HK Worsted Mills, Industrial Building
31-39 Wo Tong Tsui Street
Hong Kong, Kwai Chung, N.T.
www.nilfisk.com

HUNGARY

Nilfisk-Advance Kereskedelmi Kft.
H-2310 Szigetszentmiklós-Lakihegy
II. Rákóczi Ferenc út 10
www.nilfisk.hu

INDIA

Nilfisk-Advance India Limited
Pramukh Plaza, "B" Wing, 4th floor, Unit No. 403
Cardinal Gracious Road, Chakala
Andheri (East), Mumbai 400 099
www.nilfisk.com

IRELAND

Nilfisk-Advance
1 Stokes Place
St. Stephen's Green
Dublin 2, Ireland
www.nilfisk.ie

ITALY

Nilfisk-Advance S.p.A.
Strada Comunale della Braglia, 18
26862 Guardamiglio (LO)
www.nilfisk.it

JAPAN

Nilfisk-Advance Inc.
1-6-6 Kita-shinyokohama
Kouhoku-ku
Yokohama, 223-0059
www.nilfisk-advance.co.jp

KOREA

Nilfisk-Advance Korea
471-4, Kumwon B/D 2F
Gunja-Dong, Gwangjin-Gu, Seoul
www.nilfisk-advance.kr

MALAYSIA

Nilfisk-Advance Sdn Bhd
SD 33, Jalan KIP 10
Taman Perindustrian KIP
Sri Damansara
52200 Kuala Lumpur
Malaysia
www.nilfisk.com

MEXICO

Nilfisk Advance de Mexico S. de R.L. de C.V.
Agustin M. Chavez 1, PB-004
Col. Centro Ciudad Santa Fe
C.P. 01210 México, D.F.
www.nilfisk-advance.com.mx

NEW ZEALAND

Nilfisk-Advance NZ Ltd
Danish House
6 Rockridge Avenue
Penrose Auckland NZ 1135
www.nilfisk.com.au

NORWAY

Nilfisk-Advance AS
Bjørnerudveien 24
N-1266 Oslo
www.nilfisk.no

PORTUGAL

Nilfisk-Advance
Sintra Business Park
Zona Industrial Da Abrunheira
Edificio 1, 1º A
P2710-089 Sintra
www.nilfisk.pt

RUSSIA

Nilfisk-Advance LLC
Vyatskaya str. 27, bld. 7, 1st floor
Moscow, 127015
www.nilfisk.ru

SOUTH AFRICA

WAP South Africa (Pty) Ltd
12 Newton Street
1620 Spartan, Kempton Park
www.wap.co.za

SPAIN

Nilfisk-Advance, S.A.
Torre D'Ara
Passeig del Rengle, 5 Plta. 10ª
Mataró, E-0830222
www.nilfisk.es

SWEDEN

Nilfisk
Sjöbjörnsvägen 5
117 67 Stockholm
www.nilfisk.se

SWITZERLAND

Nilfisk-Advance AG
Ringstrasse 19
Kirchberg/Industrie Stelz
Wil, CH-9500
www.nilfisk.ch

TAIWAN

Nilfisk-Advance Ltd.
Taiwan Branch (H.K.)
No. 5, Wan Fang Road, Taipei
www.nilfisk-advance.com.tw

THAILAND

Nilfisk-Advance Co. Ltd.
89 Soi Chokechai-Ruammitr
Viphavadee-Rangsit Road
Jomphol, Jatuchak
Bangkok 10900
www.nilfisk.com

TURKEY

Nilfisk-Advance A.S.
Şerifali Mh. Bayraktar Bulv. Sehit Sk. No: 7
Ümraniye, Istanbul 34775
www.nilfisk.com.tr

UNITED KINGDOM

Nilfisk (A Division of Nilfisk-Advance Ltd)
Nilfisk House
24 Hillside Road
Bury St Edmunds, Suffolk
IP32 7EA
www.nilfisk.co.uk

UNITED ARAB EMIRATES

Nilfisk-Advance Middle East Branch
SAIF-Zone, P. O. Box 122298
Sharjah
www.nilfisk.com

VIETNAM

Northern
Nilfisk-Advance Co.Ltd.
No.51 Doc Ngu Str.
Lieu Giai Ward
Ba Dinh Dist. Hanoi
www.nilfisk.com

Southern

Pan Trading JSC
236/43/2 Dien Bien
Phu Str. Ward 17
Binh Thanh Dist. HCMC
www.nilfisk.com